

### Kit di codifica



Colore	Codice acquisto
nero	0505-4118-01
rosso	<b>0505-4118-0102</b>
verde	0505-4118-0103

Policarbonato PC UL 94 V-0 - Temperatura -40°C a +115°C

### Molla di contatto IEEE



Codice acquisto
0505.3904

Bronzo

➤➤➤ Molla di contatto per Kit di codifica

### Spina di codifica

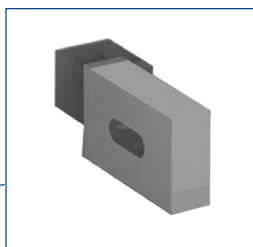
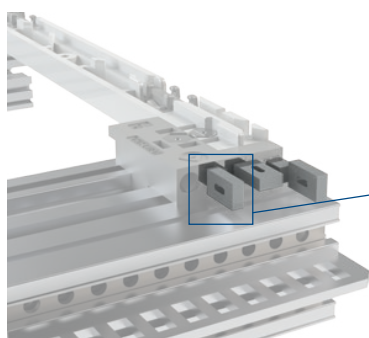

Codice acquisto
0505.1201.02

Policarbonato PC UL 94 V 0  
Temperatura -40°C a +115°C

## Chiodino fissaggio scheda

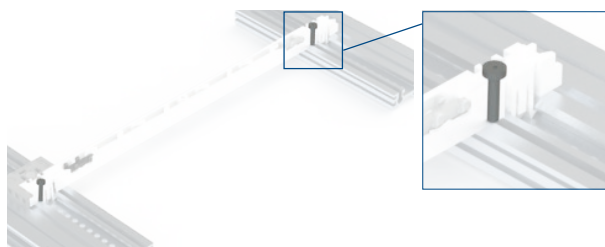

### Codice acquisto

0505.8001

Plastica PBT UL 94 V 0 - Colore nero - Temperatura -40°C a +115°C

Il chiodino viene utilizzato in alternativa alla vite di fissaggio

**NUMERO BREVETTO: BR16500**

## Viti fissaggio scheda M2,5 x12



Tipologia testa	Materiale	Codice acquisto
Torx	Acciaio 8.8	1000.0112.2512
Croce	Acciaio 8.8	<b>1000.0104.2512</b>
Croce	Inox	1000.1104.2512

Acciaio 8.8 - Inox

## Antivibranti

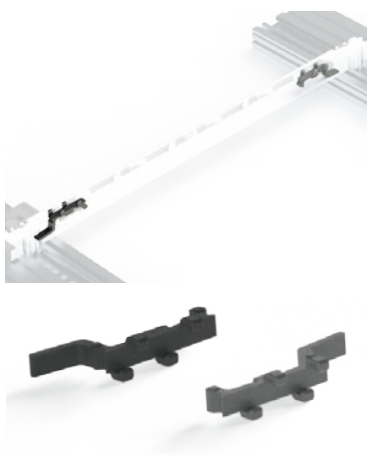

Colore	Conduttivo	Spessore scheda mm	Materiale	Codice acquisto
Grigio	Non conduttivo	1.6	PC	0505.6401.16
Nero	Non conduttivo	2	PC	<b>0505.6401.20</b>
Nero	Conduttivo	1.6	Denistat Y 30C 02 Resistività 5 Ohm	0505.6402.16
Nero	Conduttivo	2	Denistat Y 30C 02 Resistività 5 Ohm	<b>0505.6402.20</b>

Il codice comprende un antivibrante anteriore e posteriore

## Molla di contatto scheda

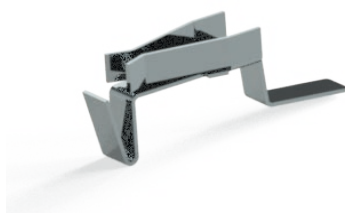
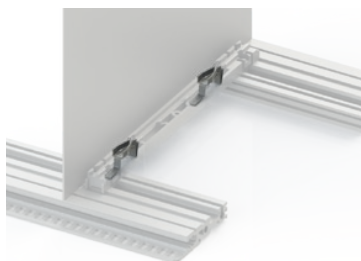

### Codice acquisto

0505.6403

Bronzo nichelato

## Blocca scheda grigio

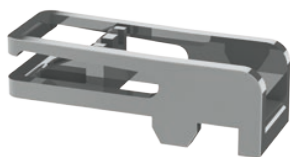

## Codice acquisto

0505.3901.01

Plastica PBT UL 94 V 0

## Estrattore



## Codice acquisto

0505.4001.03

Nylon PA66 + 30 % FV

## Perno di codifica

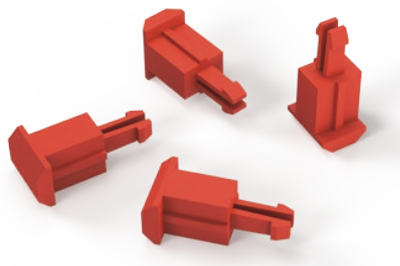

## Codice acquisto

0505.1201

Nylon PA66 + 30 % FV

 il codice si riferisce al singolo perno

## Alveolo di codifica



## Codice acquisto

0505.1203

Nylon PA66 + 30 % FV

## Pettini di codifica

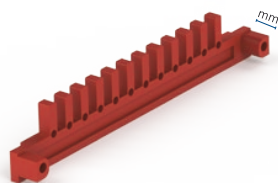

## Misura mm

## Codice acquisto

6

0505.1202.03

4,2

0505.1202.04

3,46

0505.1202.06

Nylon PA66 + 30 % FV

## Invito scheda

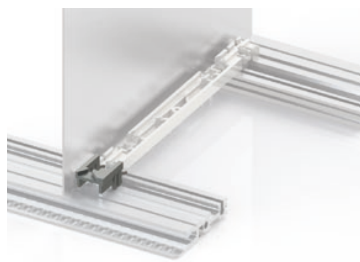

## Codice acquisto

0505.3903

Policarbonato PC UL 94 V 0  
 Colore grigio  
 Temperatura -40°C a +115°C

Il codice comprende superiore e inferiore

## Strisce numerate

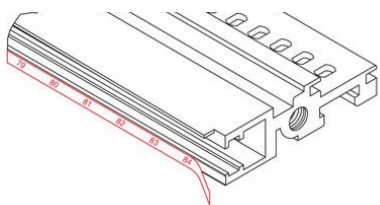

Codice acquisto	Codice acquisto
da 01 a 42	0505.5901.0142
<b>da 01 a 84</b>	<b>0505.5901.0184</b>
da 42 a 01	0505.5901.4201
<b>da 84 a 01</b>	<b>0505.5901.8401</b>

